



INTAKE SYSTEMS FOR VEHICLES LISTED ARE 50 STATE LEGAL. SEE KNFILTERS.COM FOR CARB STATUS ON EACH PART FOR A SPECIFIC VEHICLE.

# INSTALLATION INSTRUCTIONS

**57-2574**  
**FORD**  
**2007-08 F-150**  
**V8-4.6L**

**NOTE:** This kit was not designed to fit vehicles with a body lift.

**TOOLS NEEDED:**

- Flat Blade Screwdriver
- Phillips Screwdriver
- Ratchet
- Extension
- 10mm Socket
- 13mm Socket
- 14mm Socket
- 13mm Wrench
- T-20 Torx Wrench
- 5/32" Allen Wrench
- Drill
- 1/8" Drill Bit

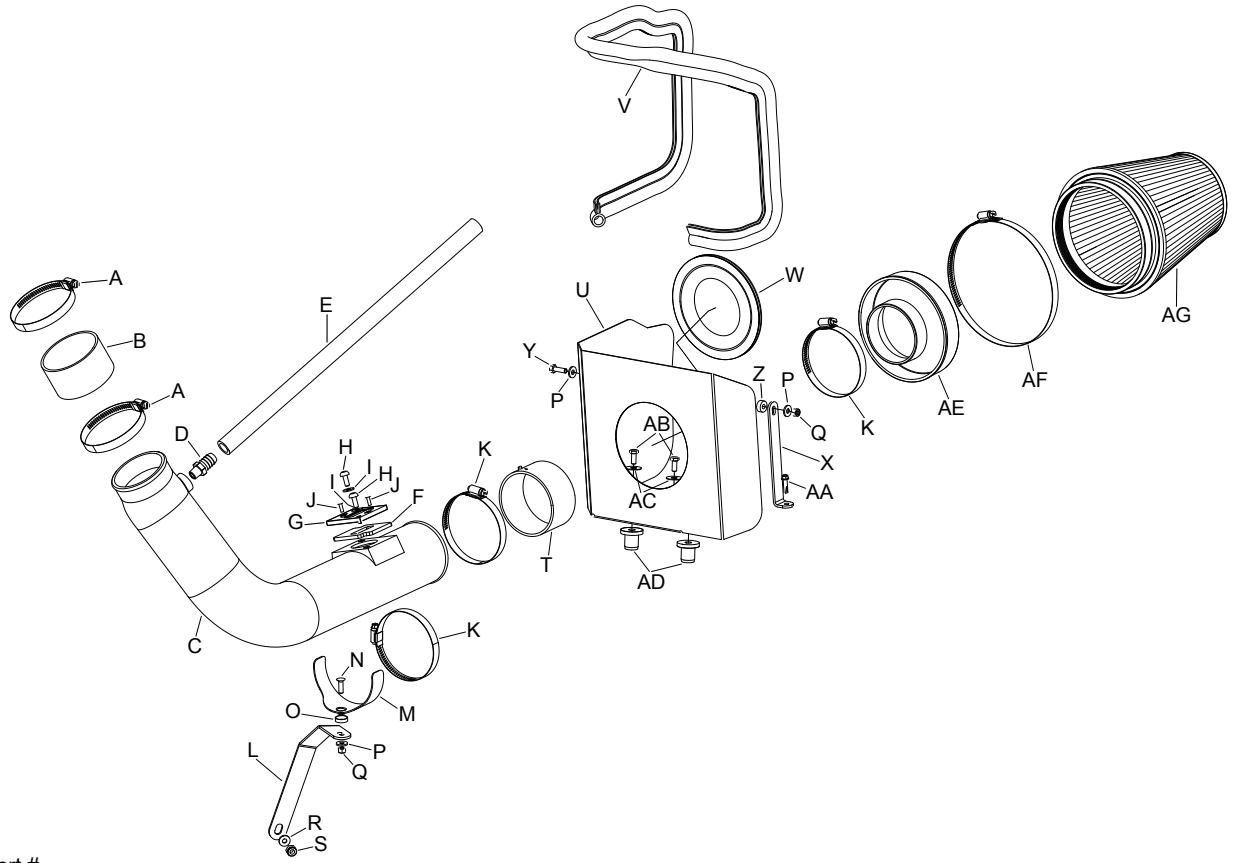

**PARTS LIST:**

Description	Qty.	Part #	Description	Qty.	Part #	Description	Qty.	Part #
A Hose Clamp #52	2	08610	L Bracket; "L," STL, FB/PC	1	06493	W Edge Trim (17")	1	102469
B Hose; 3.25" ID X 2"L, Black Silicone	1	08690	M Bracket; Saddle, S/S	1	078855	X Bracket; Small "L"	1	070026
C Intake Tube	1	087217A	N Bolt; 6MM-1.00 X 20MM F/H/A, SS	1	08376	Y Bolt; M6 X 1.00 X 20MM Hex, SS	1	07795
D Vent; STRT, 5/8" Barbed 1/4 NPT, Nylon	1	08911-1	O Washer; Conical, Nylon, Black	1	08180	Z Spacer; .625" OD X .250" ID X .250"L, AL	1	06555
E Hose; 5/8" ID X 20"L, Black Silicone	1	08542	P Washer; 1/4" ID X 5/8" OD- SAE	3	08275	AA Screw; 12/24 X 7/8 Hextek #4	1	07789
F Gasket; 3/16" Poron	1	09069	Q Nut; 6MM Nylock, Hexhead SS	2	07512	AB Bolt; 3/8"- 16 X 1-1/4"L Hex, SS	2	07779
G Adaptor; Nylon 6/6 GF, Black	1	21515	R Washer; 5-16" ID X 5/8" OD, Flat	1	08276	AC Washer; 3/8" Flat Washer, SS	2	08134
H Bolt; M6 X 1.00 X 16MM, Buttonhead, SS	2	07730	S Nut; 8MM Nylock	1	07542	AD Insert; 3/8"- 16 X 3/400 X 15/16L, Rubber	2	08163
I Washer; 6MM Flat, SS	2	08269	T Hose; 3.5"ID X 2"L, Black Silicone	1	08630	AE Adaptor; #380	1	21512-1
J Screw; M4- .7 X 12, Buttonhead, SS	2	07726	U Heat Shield	1	074021	AF Hose Clamp #104	1	08697
K Hose Clamp #56	3	08620	V Edge Trim (55")	1	102480	AG Air Filter	1	RU-1041

**If you need any assistance please call 1-800-858-3333 to speak with a representative in our Customer Service Center before returning the product.**

**NOTE: FAILURE TO FOLLOW INSTALLATION INSTRUCTIONS AND NOT USING THE PROVIDED HARDWARE MAY DAMAGE THE INTAKE TUBE, THROTTLE BODY AND ENGINE.**

**TO START:**

1. Turn off the ignition and disconnect the negative battery cable.

**NOTE: Disconnecting the negative battery cable erases pre-programmed electronic memories. Write down all memory settings before disconnecting the negative battery cable. Some radios will require an anti-theft code to be entered after the battery is reconnected. The anti-theft code is typically supplied with your owner's manual. In the event your vehicles' anti-theft code cannot be recovered, contact an authorized dealership to obtain your vehicles anti-theft code.**



2. Rotate the crank case vent hose locking ring and disconnect the crank case vent hose from the valve cover.



3. Loosen the stock intake tube hose clamps and remove the intake tube assembly from the vehicle.



4. Un-hook the secondary mass air sensor electrical connection from the power steering reservoir bracket. Depress the electrical connection locking tabs and separate the electrical connection.



5. Pull up firmly on the air box, removing it from the mounting grommets.  
**NOTE: K&N Engineering, Inc., recommends that customers do not discard factory air intake.**

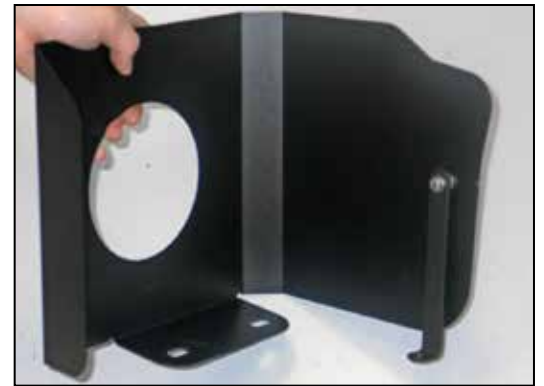

6. Install "L" bracket (#070026) onto the heat shield with the provided hardware.

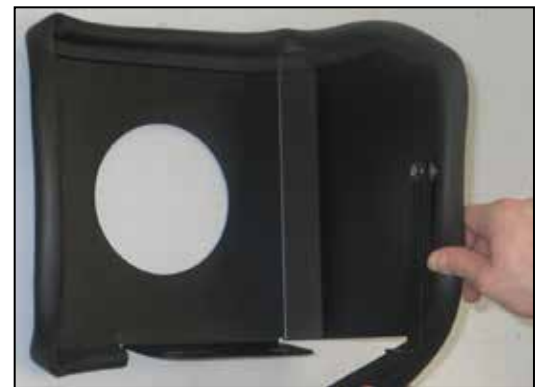

7. Install the long edge trim onto the heat shield as shown.  
**NOTE: Some trimming of the edge trim may be necessary.**



8. Install the short edge trim into the hole in the heat shield as shown.

**NOTE: Some trimming of the edge trim may be necessary.**



9. Remove the factory air box mounting grommets and replace them with the provided nut inserts as shown.

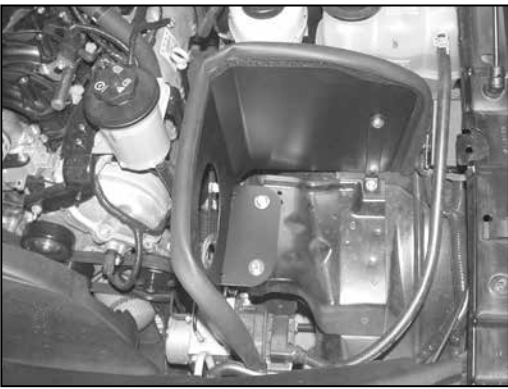

10. Install the heat shield and secure with the provided hardware as shown.

**NOTE: Due to vehicle manufacturing inconsistencies, some vehicles may not be equipped with the threaded hole in the factory filter mounting plate. In this case, it will be necessary to drill a 1/8" ID hole in the filter mounting plate and attach the heat shield mounting bracket with the provided sheet metal screw.**



11. Release the factory air box clam shell clamp, then separate the mass air sensor housing from the factory air box.



12. Slide the rubber wiring harness plug back, exposing the mass air sensor electrical connection.



13. Release the mass air sensor electrical connection.



14. Using a flat blade screw driver; push in and release the four clips that secure the mass air sensor retaining plate.



15. Remove the two mass air sensor retaining screws and remove the mass air sensor as shown.

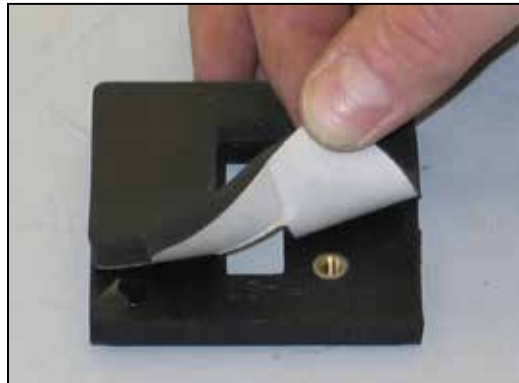

16. Install the mass air sensor gasket onto the mass air sensor adapter as shown.

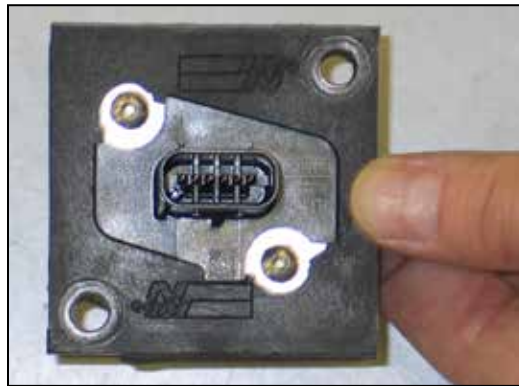

17. Install the mass air sensor into the mass air sensor adapter and secure the assembly with the provided hardware.

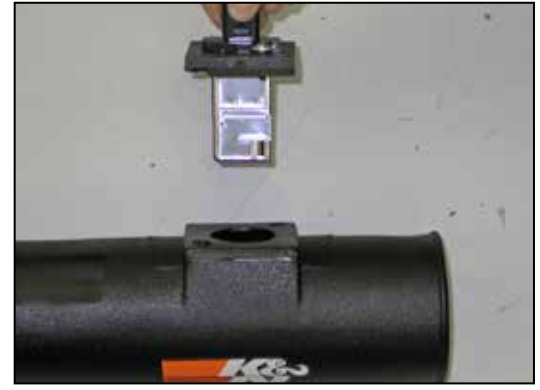

18. Install the mass air sensor assembly into the K&N® intake tube and secure with the provided hardware as shown.

**NOTE: The opening in the mass air sensor should be installed facing towards the air filter end of the intake tube.**



19. Install the 1/4" NPT fitting into the K&N® intake tube as shown.

**NOTE: Plastic NPT fittings are easy to cross thread. Install the vent fitting "hand" tight, then turn it two complete turns with a wrench.**



20. Install silicone hose (#08690) onto the throttle body and secure with the provided hose clamp.



21. Install the saddle bracket onto the tube mounting bracket and secure the assembly with the provided hardware as shown.



22. Install the tube mounting bracket assembly onto the stud protruding from the cylinder head. Secure with the provided hardware.



23. Install the K&N® intake tube into the silicone hose at the throttle body and align the intake tube with the saddle clamp. Secure the intake tube with the provided hose clamps.



24. Connect the provided crank case vent hose onto the fitting on the valve cover and the vent fitting on the K&N® intake tube.



25. Install the air filter adapter into the K&N® air filter and secure the assembly with the provided hose clamp.

**NOTE: Drycharger® air filter wrap; part # RF-1041DK is available to purchase separately. To learn more about Drycharger® filter wraps or look up color availability please visit <http://www.knfilters.com>®.**



26. Install silicone hose (#08630) onto the air filter adapter and secure with the provided hose clamp.



27. Install the air filter assembly onto the K&N® intake tube and secure with the provided hose clamp.



28. Re-attach the mass air sensor secondary connection to the power steering reservoir bracket, then connect the mass air sensor electrical connections as shown.



29. Reconnect the vehicle's negative battery cable. Double check to make sure everything is tight and properly positioned before starting the vehicle.

30. The C.A.R.B. exemption sticker, (attached), must be visible under the hood so that an emissions inspector can see it when the vehicle is required to be tested for emissions. California requires testing every two years, other states may vary.

31. It will be necessary for all K&N® high flow intake systems to be checked periodically for realignment, clearance and tightening of all connections. Failure to follow the above instructions or proper maintenance may void warranty.

#### ROAD TESTING:

1. Start the engine with the transmission in neutral or park, and the parking brake engaged. Listen for air leaks or odd noises. For air leaks secure hoses and connections. For odd noises, find cause and repair before proceeding. This kit will function identically to the factory system except for being louder and much more responsive.

2. Test drive the vehicle. Listen for odd noises or rattles and fix as necessary.

3. If road test is fine, you can now enjoy the added power and performance from your kit.

4. K&N Engineering, Inc., requires cleaning the intake system's air filter element every 100,000 miles. When used in dusty or off-road environments, our filters will require cleaning more often. We recommend that you visually inspect your filter once every 25,000 miles to determine if the screen is still visible. When the screen is no longer visible some place on the filter element, it is time to clean it. To clean and re-oil, purchase our filter Recharger® service kit, part number 99-5050 or 99-5000 and follow the easy instructions.

**INTAKE SYSTEMS FOR VEHICLES LISTED ARE 50 STATE LEGAL. SEE KNFILTERS.COM FOR CARB STATUS ON EACH PART FOR A SPECIFIC VEHICLE.**